

nano



ultra-high purity compressed air dryers

flow capacity: 3 - 1110 scfm (5 - 1900 Nm³/hr)

D^{1|2|3}

ultra-high purity compressed air dryers

flow capacity: 3 - 1110 scfm (5 -1900 Nm³/hr)

D^{1|2|3}

Leading edge technology and more than 100 years of **experience**...nano-purification solutions, your world-class provider of state-of-the-art compressed air and gas solutions to industry.

Our commitment at n-psi is to work alongside our **customers** and provide unique solutions with the highest quality products to solve your specific challenges.

A wealth of experience and leading edge products are only part of the equation. n-psi realize that world-class customer **service** is the most important component to any successful business.

Experience. Customer. Service... **n-psi**



clean and dry

Clean and dry compressed air is essential in every efficient and profitable manufacturing and process operation worldwide. nano-purification solutions' vast experience includes food, beverage, chemical, laboratory, medical and natural gas applications.

n-psi understands your needs and has created the nano range of high-performance, energy-saving compressed air and gas purification products to provide clean and dry compressed air and gases at an affordable price with unrivaled reliability.

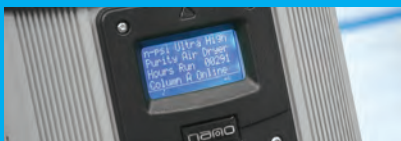

design

Our experienced team of design engineers are world leading specialists in the design of new and unique industrial compressed air treatment products and compressed air dryers.



research & development

A core element of our capabilities - founded on cumulative decades of practical engineering expertise - our R&D team is continually looking for improved performance and reliability.



manufacture

Ultra-high purity compressed air dryers are manufactured at our state of the art facility to the highest standards of build quality to ensure equipment reliability and high levels of performance.

nano D^{1|2|3} compressed air dryers

Clean and dry compressed air is easily achieved with nano ultra-high purity compressed air dryers.

nano dryers reliably give you:

- more for your money - everything needed for installation is in the box
- moisture and particulate protection of your production process
- lower life cycle costs - low energy costs and simplified maintenance
- built in dew point monitoring (optional)
- space saving - models up to 177 scfm can be easily wall mounted
- safe and quiet operation
- flows from 3 to 1110 scfm at 100 psig operating pressure
- peace of mind - the most reliable product of its kind

Designed for use in the compressor room, at the point of application or integrated into your original equipment, nano dryers are an effective solution to the problems caused by contaminated compressed air.



reliability is built in... and backed by our 5 year* product warranty

benefits - get more for your money

guaranteed performance

- nano dryers have been 100% function and performance tested at the factory to ensure the highest standard of performance, delivering compressed air purity in accordance with ISO8573:1 – 2001, Class 2 dirt (1 micron) and Class 2 water (-40° F pressure dew point)

reliable operation

- high efficiency moisture removal and reliable operation with PLC controlled solenoid valves
- integral volumetric flow limiter prevents overflow ensuring consistent dew point performance

quiet depressurization

- unique exhaust air silencers significantly reduce noise levels

energy saving design

- integrated inlet separator (D¹ only) and outlet filtration eliminates the need for external filters
- advanced design limits regeneration purge air usage to approximately 15%
- energy saving dew point monitoring option can save up to 60% during reduced inlet moisture loading

PLC controls and digital display

- a clear digital display provides a full view of PLC operation and monitoring data

high quality construction

- 100% tested for leaks, proper operation and dew point performance

easy to install space saving design

- easy to install & ready for use, the D¹ & D² packages include a power cable and mounting brackets for either floor or wall mounting
- the compact design allows installation in spaces too small for a traditional dryer

easy to maintain

- patented, combined filter and desiccant cartridges (D¹ & D²) can be serviced in less than 15 minutes
- integrated inlet separator (D¹ only) and outlet filtration
- convenient service kits for easy and efficient maintenance
- integrated exhaust air silencers require no maintenance or replacement

* standard two year warranty extends to five years automatically with addition of the -ES (energy saving dew point control) option on all D1|2|3 dryers.

nano dryers – D¹ & D² in detail

patented combined filter & desiccant cartridges

- built in inlet water separator (D¹ only) eliminates the cost and pressure drop of installing a separate inlet filter in small oil-free compressor applications*
- desiccant and outlet filtration are integrated into a single cartridge (eliminates the cost and pressure drop of installing separate filters)
- high density filled desiccant provides maximum adsorption capacity
- easy to replace cartridges simplify maintenance requirements

PLC controlled operation

- the dryer is operated by a robust and reliable PLC control system offering valuable features including 'power on', 'hours run' and 'service required' indicators
- memory retention built into the PLC enables the controller to pick up where it left off in the drying cycle, ensuring consistently clean and dry air downstream
- compressor synchronization is a standard energy saving feature which starts and stops the dryer with a signal from the compressor or point-of-use equipment to eliminate purge loss when drying is not required

energy saving dew point control option

- with this option, a dew point sensor is incorporated into the dryer providing the ultimate in energy savings
- the outlet dew point is constantly monitored allowing the cycle time to be adjusted depending on the actual moisture load - saving valuable purge air
- dew point is conveniently displayed on the PLC
- The -ES option reduces valve actuation increasing service life and includes an extended 5-year valve warranty



floor or wall installation

- can be floor or wall mounted - simply by rotating the feet 90°

optimum dew point performance

- dryers are provided as standard set for a -40°F dew point. Optional dew points from -4°F to -94°F are available
- air velocity and, therefore, air to desiccant contact time, is carefully controlled via a pressure maintaining device to ensure optimum dew point performance

constant flow and pressure

- pressure is equalized before switching columns to ensure uninterrupted compressed air and consistent air pressure. Equalization also ensures long desiccant life due to minimized desiccant attrition

reliable high performance valves

- the NDL 010 to 050 use ball valves and two pilot operated solenoid valves for proven performance and reliability
- the NDL 060 to 090 use four pilot operated solenoid valves
- the NDL 100 to 130 use two integrated coaxial flow valves for inlet air and two pilot operated solenoid valves for exhaust

maximum corrosion protection

- high tensile aluminum columns are alocromed then externally powder coated to provide maximum protection for corrosive environments



* applies to the D¹ only. For oil flooded compressors, an upstream coalescing inlet filter is required

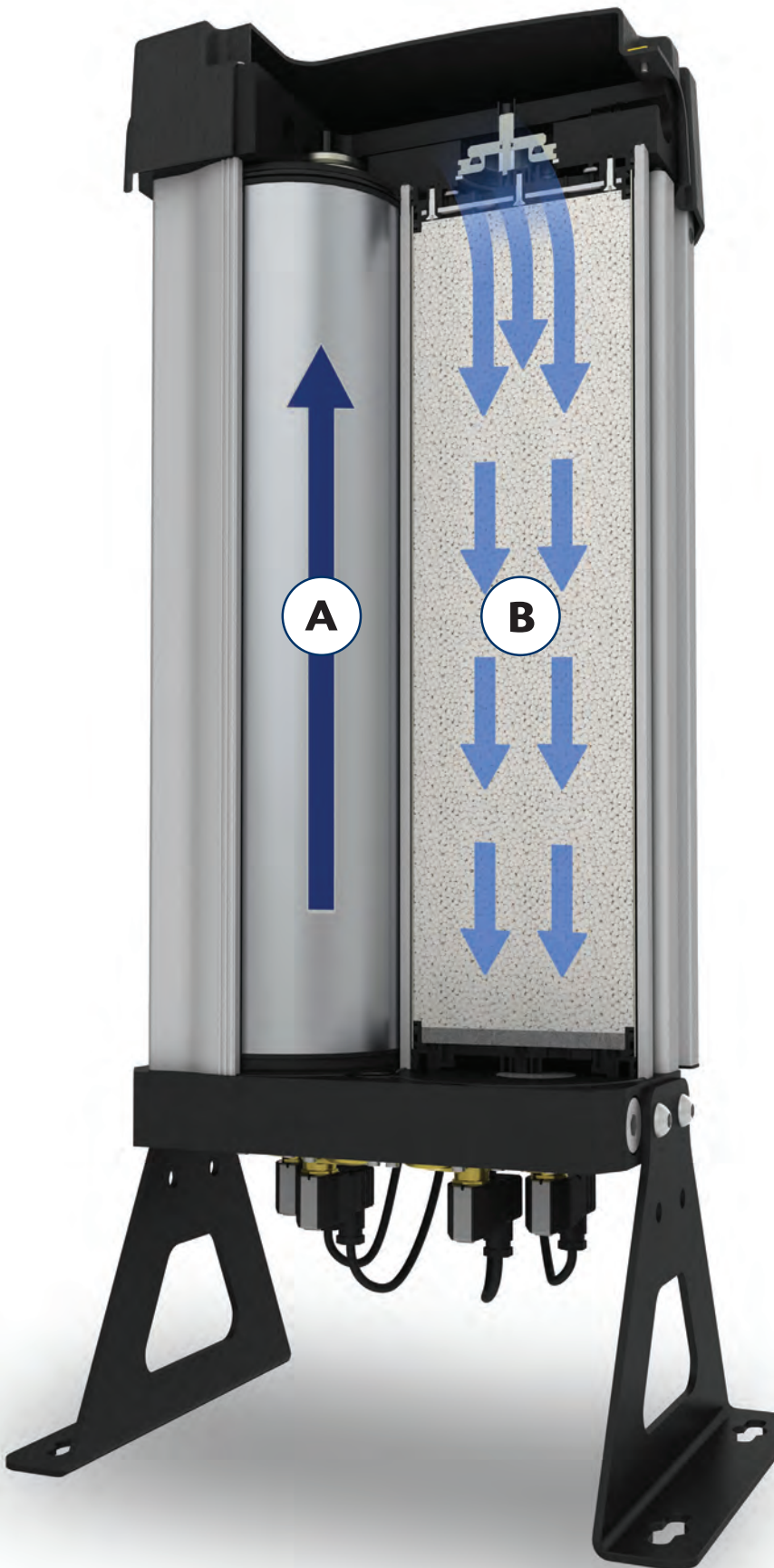

These advanced dryers use the pressure swing adsorption principle to efficiently dry compressed air. They use a heatless twin tower configuration (see diagram opposite) housed in a modular design. Each column contains a unique (and patented) desiccant cartridge which incorporates an inlet separator (D¹ only) and outlet filtration.

Wet air from the compressor aftercooler enters the dryer and is directed into column A.

D¹ only: Bulk liquids (water) and particles are removed by the separator on the inlet of the cartridge. Water is retained within the dryer until the column is regenerated, when it will be vented to atmosphere as it is depressurized.

D¹ & D²: Air passes through the desiccant bed where moisture vapor is adsorbed. Then the dry air passes through a particle filter which retains any desiccant particles (< 1 micron / ISO8573.1 class 2 for dust).

Simultaneously, a small amount of dry air is counter-flowed down through cartridge B and exhausted to atmosphere, removing the moisture and regenerating the desiccant.

The dryer is controlled by a PLC which periodically switches the solenoid valves, reversing the function of each column and therefore ensuring the continuous supply of dry air.

Scan this tag with your mobile device to download a technical paper describing the performance limitations of typical twin tower desiccant dryers and how the unique design of the nano D^{1/2/3} overcomes them to provide effective and efficient dehydration of compressed air.



unique patented cartridge design



PLC controls with clear text display

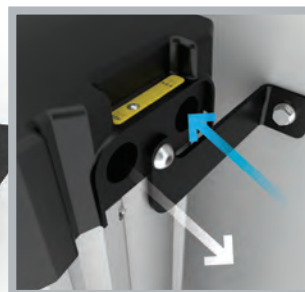

flexible piping & installation options

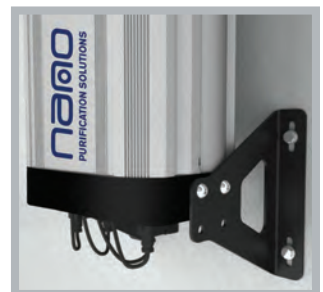

mount on the floor or the wall

nano dryers – D³ in detail

combined desiccant & after filter column

- high density filled desiccant columns provides maximum adsorption capacity
- built in after filter ensures reliable downstream air quality

PLC controlled operation

- the dryer is operated by a robust and reliable PLC control system, offering valuable features including 'power on', 'hours run' and 'service required' indicators
- memory retention built into the PLC enables the controller to pick up where it left off in the drying cycle, ensuring consistently clean and dry air downstream
- compressor synchronization is a standard energy saving feature which starts and stops the dryer with a signal from the compressor or point-of-use equipment to eliminate purge loss when drying is not required

energy saving dew point control option

- with this option, a dew point sensor is incorporated into the dryer providing the ultimate in energy savings
- the outlet dew point is constantly monitored allowing the cycle time to be adjusted depending on the actual moisture load saving valuable purge air
- dew point is conveniently displayed on the PLC
- the -ES option reduces valve actuation increasing service life and includes an extended 5-year valve warranty



optimum dew point performance

- dryers are provided as standard set for a -40°F dew point. Optional dew points from -4°F to -94°F are available

constant flow and pressure

- pressure is equalized before switching columns to ensure uninterrupted compressed air and consistent air pressure. Equalization also ensures long desiccant life due to minimized desiccant attrition

two stage maintenance free silencer

- exhaust air is directed into perforated chambers housed within the lower manifold eliminating external mufflers. The air is then directed under the dryer away from operators and traffic lanes in the compressor room

maximum corrosion protection

- high tensile aluminum columns are first alocromed and then externally powder coated to provide maximum protection for corrosive environments

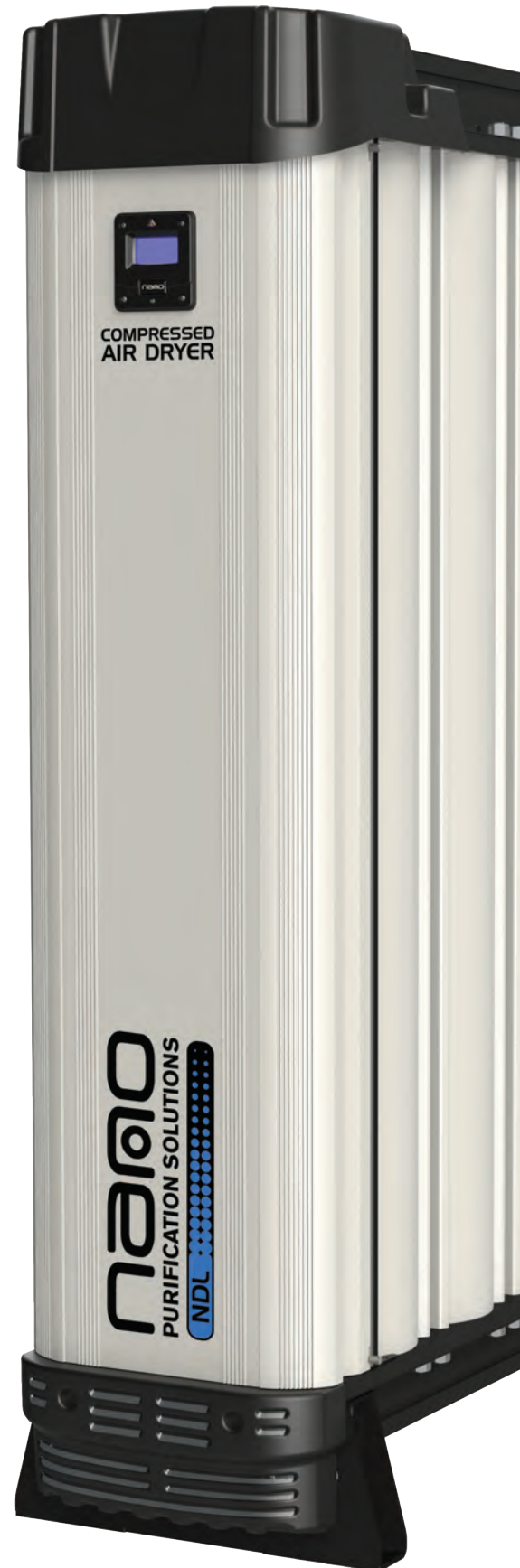

PLC controller with clear text display



high density filled desiccant columns



flexibility is built right in

We've designed the D³ with simplicity of service in mind. As standard, the columns are high density filled and include a built in after filter for reliable downstream air quality. For even greater ease of service, pre-filled and pre-assembled desiccant / after filter cartridges are available as a time saving option.

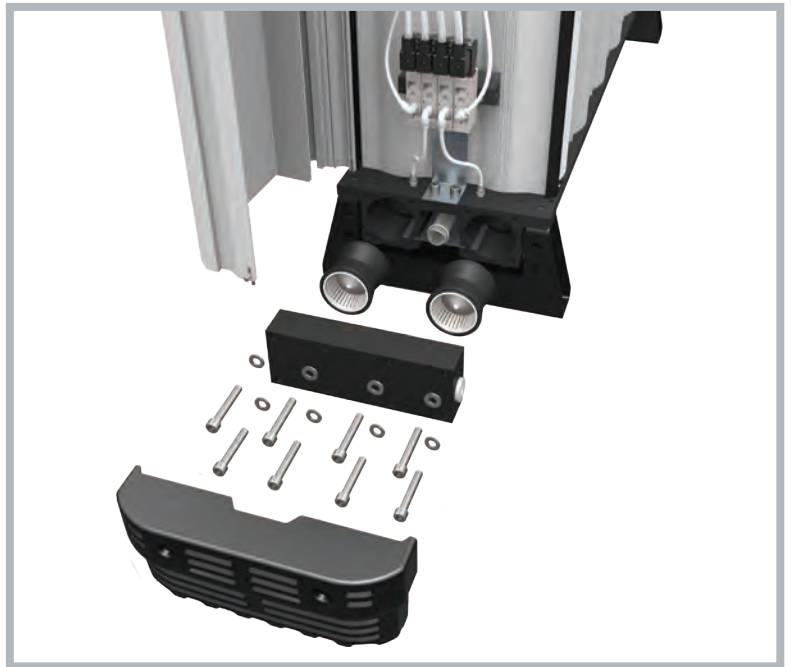

reliable high performance valves

Inlet, exhaust and outlet air are controlled using coaxial flow valves integrated into the upper and lower manifolds. The valves provide unrestricted flow capacity and are designed for durability, ease of maintenance and long service life.

sizing & specifications

dryer model	inlet & outlet		rated flow ⁽²⁾	dimensions (inches)			approx. weight	recommended pre filter ⁽³⁾
	NPT(f) ⁽¹⁾	scfm		Nm ³ /h	A	B		
D¹								
NDL 010	3/8" (1)	3	5.1	17	9	10	18	NF 0008 M01
NDL 020	3/8" (1)	5	8.5	17	9	10	18	NF 0008 M01
NDL 030	3/8" (1)	10	17	25	9	10	28	NF 0015 M01
NDL 040	3/8" (1)	15	26	35	9	13	36	NF 0015 M01
NDL 050	1/2" (1)	24	41	43	9	13	43	NF 0025 M01
D²								
NDL 060	1"	34	58	30	17	13	88	NF 0090 M01
NDL 070	1"	41	70	30	17	13	88	NF 0090 M01
NDL 080	1"	53	90	36	17	13	119	NF 0090 M01
NDL 090	1"	66	112	36	17	13	119	NF 0090 M01
NDL 100	1"	88	150	43	17	13	141	NF 0090 M01
NDL 110	1"	106	180	49	17	13	172	NF 0135 M01
NDL 120	1"	132	224	59	17	13	209	NF 0175 M01
NDL 130	1"	177	301	72	17	13	262	NF 0175 M01
D³								
NDL 2110	2"	212	360	47	12	25	366	NF 0450 M01
NDL 2120	2"	276	469	57	12	25	441	NF 0450 M01
NDL 2130	2"	400	680	70	12	25	547	NF 0450 M01
NDL 3130	2"	560	951	70	12	31	778	NF 0700 M01
NDL 4130	2 1/2"	750	1274	70	12	38	1010	NF 0850 M01
NDL 6120	2 1/2"	828	1407	57	12	51	1155	NF 0850 M01
NDL 6130	2 1/2"	1110	1886	70	12	51	1473	NF 1250 M01

specifications	standard	optional
maximum particle size (ISO class) ⁽⁴⁾	class 2 (1 micron)	class 1 (0.01 micron)
maximum water content (ISO class) ⁽⁴⁾	class 2 (-40°F pdp)	class 1 (-94°F) & class 3 (-4°F)
minimum operating pressure	58 psig	-
maximum operating pressure	145 or 232 psig ⁽⁵⁾	consult factory
recommended operating temp range	50 to 100°F ⁽⁶⁾	-
design operating temperature range	50 to 122°F ⁽⁶⁾	-
power supply requirements	100 to 240 VAC / 50 or 60 Hz	-

pressure correction factors ⁽⁷⁾												
inlet air pressure (psig)	60	75	90	100	115	130	145	160	175	190	205	235
correction factor	0.63	0.75	0.88	1	1.13	1.25	1.38	1.50	1.63	1.75	1.88	2.13

temperature & dew point correction factors ⁽⁷⁾									
inlet air temperature (°F)	75	100	104	113	122	pressure dew point (°F)	-4	-40	-94
correction factor	1	1	0.97	0.88	0.73	correction factor	1.10	1.00	0.70

- (1) NDL 010 to 050 have push to connect fittings on the inlet and outlet. All other models have NPT(F) threaded connections
- (2) at inlet conditions of 100 psig and 100°F and a -40°F outlet pressure dew point. For all other conditions refer to the correction factors above
- (3) recommended for all applications. Required when dryer is to be installed immediately downstream of an oil lubricated compressor. To order with a pre-filter add "-F" to the model number (i.e. NDL 120-F)
- (4) per ISO 8573.1:2001 (E)
- (5) NDL 010 to 130 are 232 psig MAWP as standard. NDL 2110 to 6130 are 145 psig MAWP as standard. Higher pressures available
- (6) NDL 010 to 090 have a minimum recommended operating and design temperature of 40°F
- (7) to be used as a rough guide only. All applications should be confirmed by n-psi. Contact support@n-psi.com

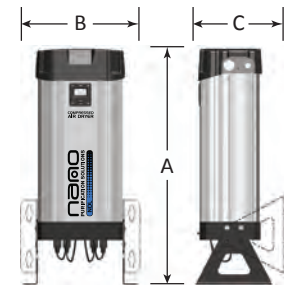

NDL 010 to 130

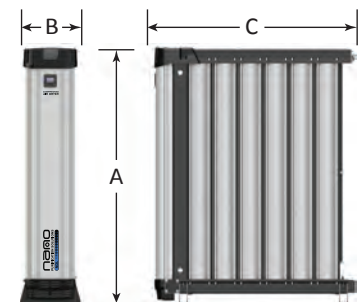

NDL 2110 to 6130

nano-purification solutions
11330 vanstony drive
huntersville, nc 28078
usa

tel: (704) 897-2182
fax: (704) 897-2183
email: support@n-psi.com
web: www.n-psi.com



nano
PURIFICATION SOLUTIONS

copyright nano-purification solutions
publication reference n-psi-D123-03-us